

M732-36

M732-38

M732-70

M732-86

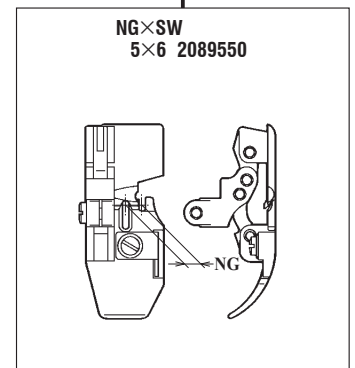
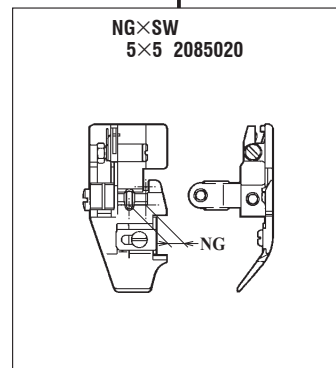
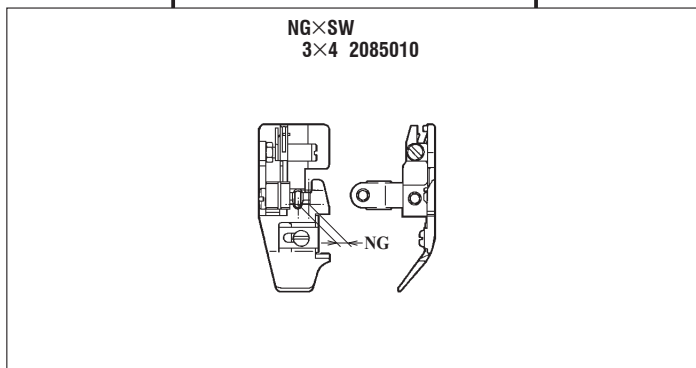
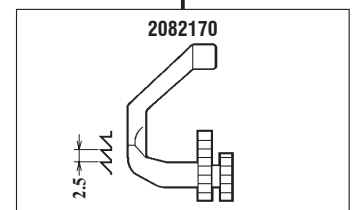
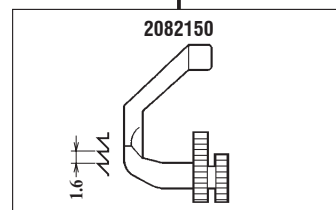
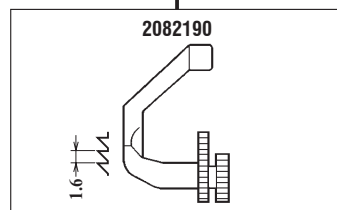
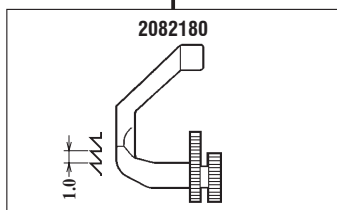
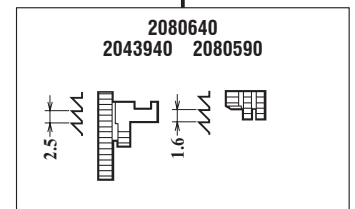
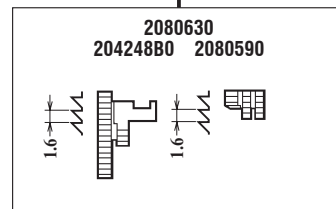
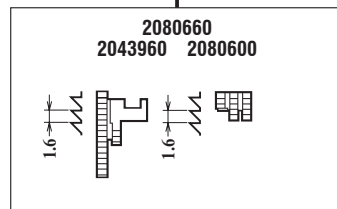
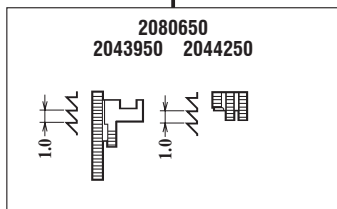
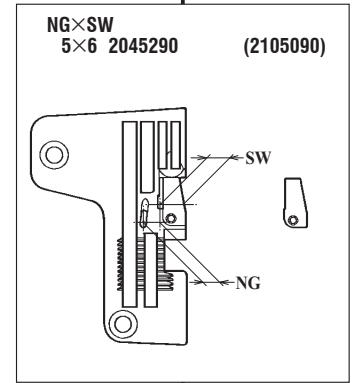
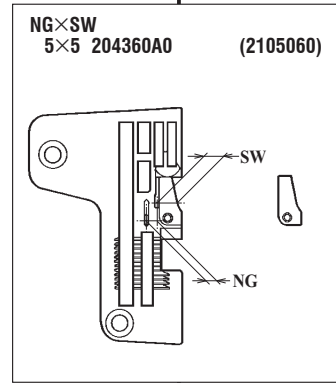
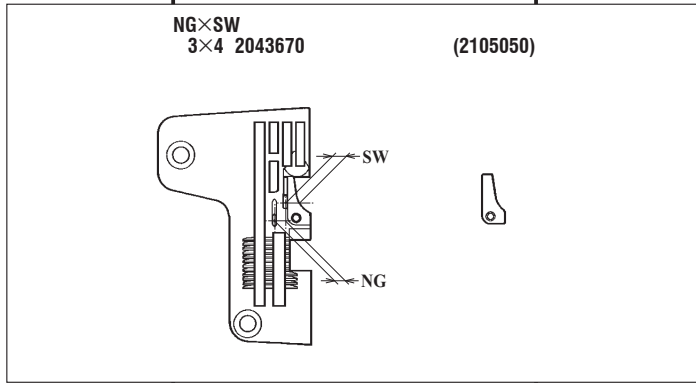

M732-36

M732-38

M732-70

M732-86

NG
3 208909B920

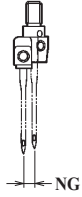

NG
5 208910B920

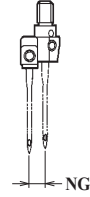

2040620 #2



2047020 #4

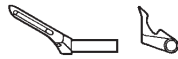

2047030 #6



2096850

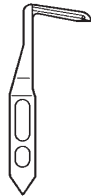

209685AC0

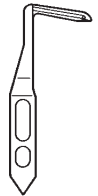

2045360

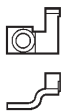

2096690

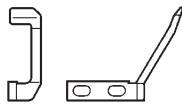

2040420



209669A0

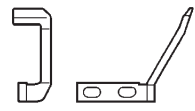

地縫用 (薄生地)
PLAIN SEAMING
(LIGHT WEIGHT FABRIC)

地縫用 (中厚生地)
PLAIN SEAMING
(MEDIUM WEIGHT FABRIC)

地縫用 (中厚生地)
PLAIN SEAMING
(MEDIUM WEIGHT FABRIC)

地縫用 (極厚生地)
PLAIN SEAMING
(EXTRA HEAVY WEIGHT FABRIC)

M732 Series
共通部品 COMMON PARTS

下ルーパー
LOWER LOOPER
2040720



上メス
UPPER KNIFE
201121A0



下メス
LOWER KNIFE
2041610

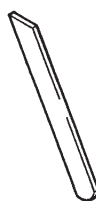

オーバーロック針受
OVERLOCK NEEDLE GUARD
2096680 2090090



ヒダ取り用
ヒダ取り・パイピング用
多用途用

M732 Series

SHIRRING
SHIRRING WHILE PIPING
MULTI PURPOSE

M732-48

M732-48P2

M732-355

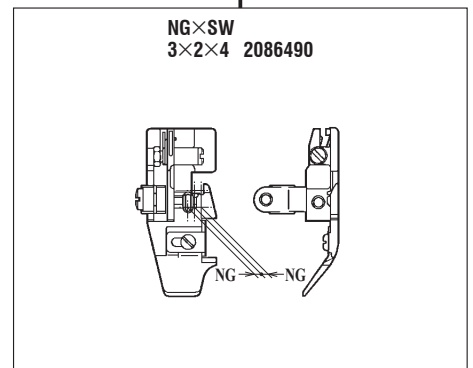
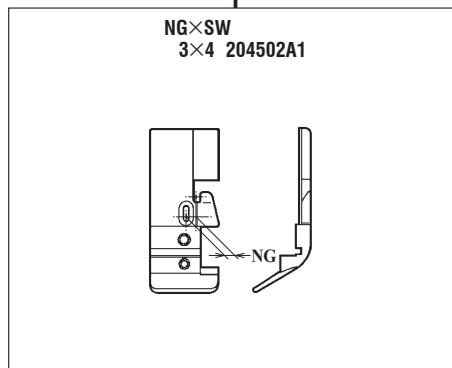
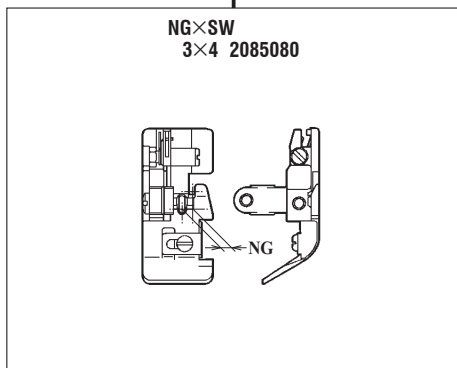
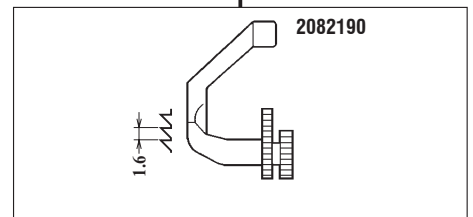
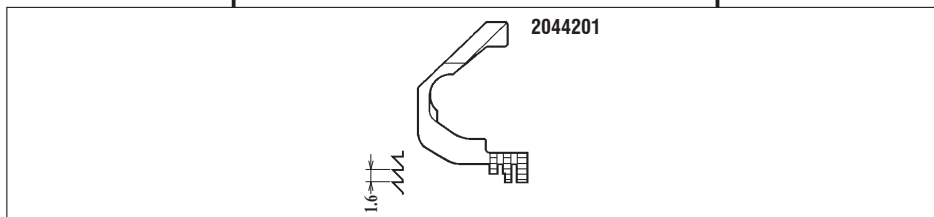
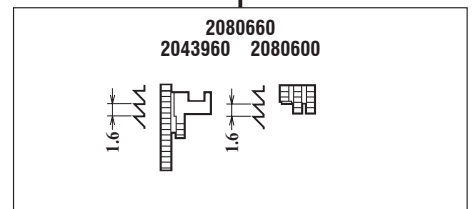
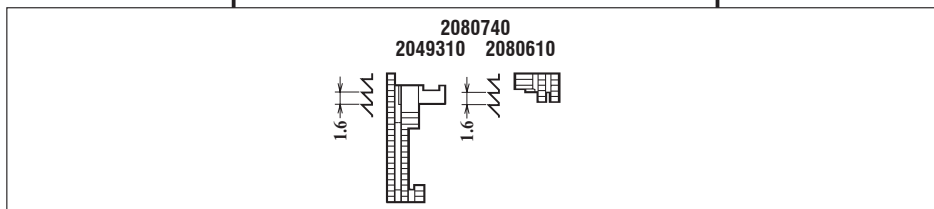
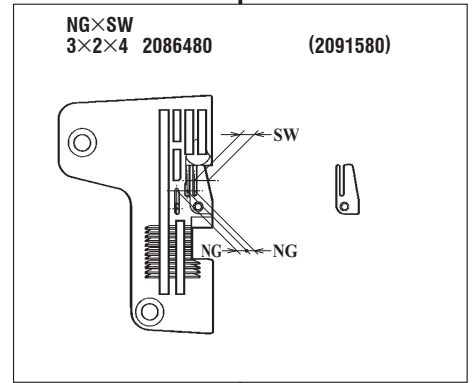
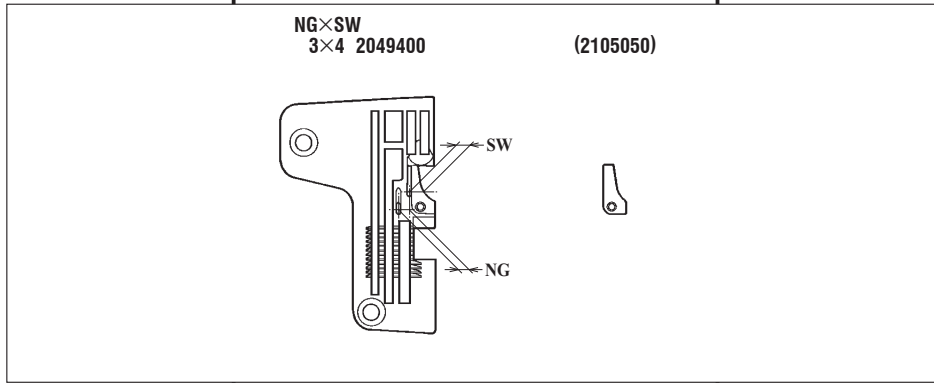

M732-48

M732-48P2

M732-355

NG
3 208909B920



NG
3×2 208965B920

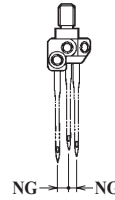

2047020 #4

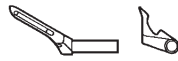

2049630 #8

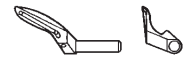

2096850

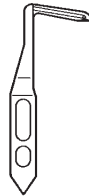

2045360

2096690

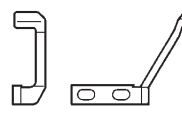
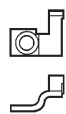

ヒダ取り用 (中厚生地)
SHIRRING
(MEDIUM WEIGHT FABRIC)

ヒダ取り・パイピング用 (中厚生地)
SHIRRING WHILE PIPING
(MEDIUM WEIGHT FABRIC)

多用途用 (中厚生地)
MULTI PURPOSE
(MEDIUM WEIGHT FABRIC)