

EX5104-02/233

EX5104-02/233N

EX5104-04/433

EX5104-04/433N

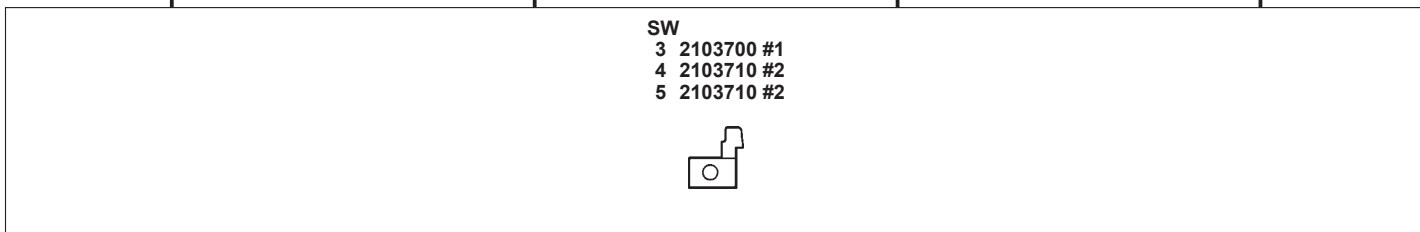
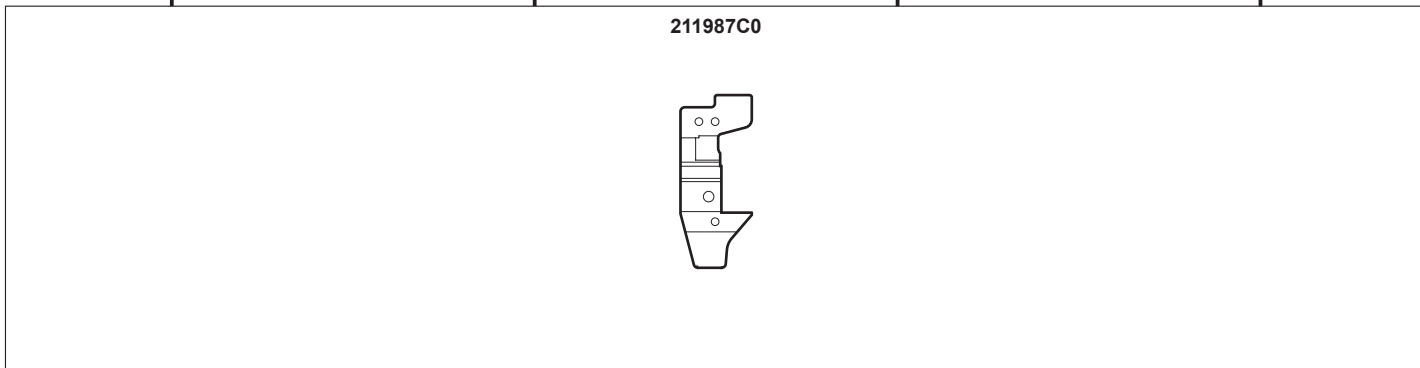
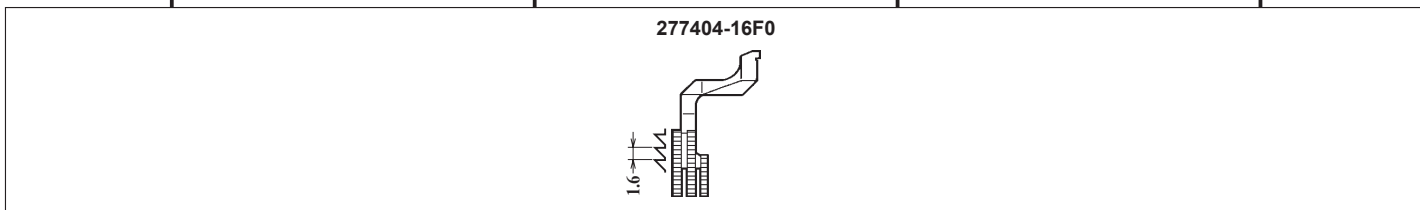
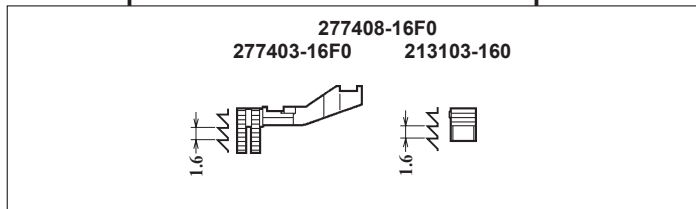
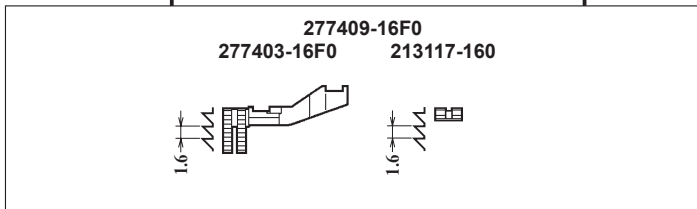
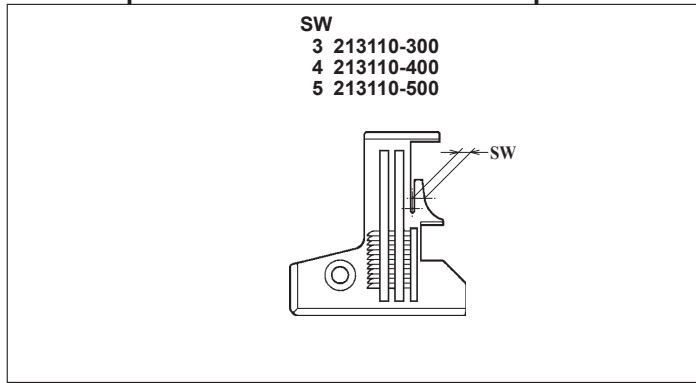
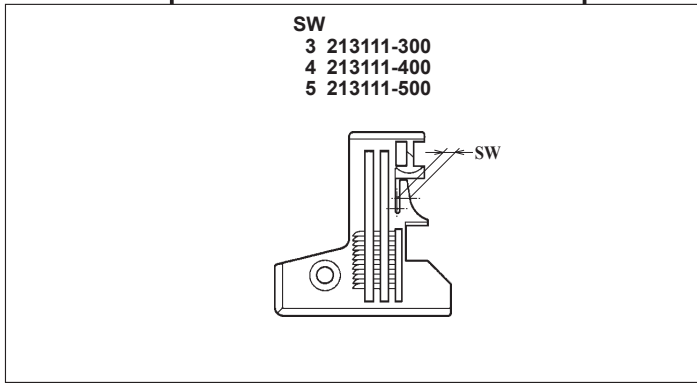

EX5104-02/233

EX5104-02/233N

EX5104-04/433

EX5104-04/433N

179630-920



277062A0 #15

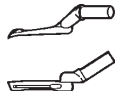

2770630 #19

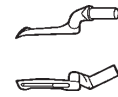

2770600

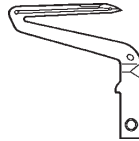

201121A0



SW

3 213108A0

4 2131080

5 2131080

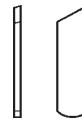

地縫用(薄~中厚生地)  
PLAIN SEAMING  
(LIGHT~MEDIUM WEIGHT FABRIC)

地縫用(厚~極厚生地)  
PLAIN SEAMING  
(HEAVY~EXTRA HEAVY WEIGHT FABRIC)

EX5100 Series  
共通部品 COMMON PARTS

針受(前) NEEDLE GUARD(FRONT)  
2131070

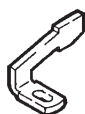

針受(後) NEEDLE GUARD(REAR)  
2770610



EX5114-03/333N

EX5114-04/433

EX5114-04/433N

NG×SW  
2×3 213112-300  
2×4 213112-400  
2×5 213112-500

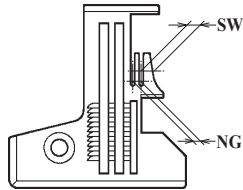

NG×SW  
2×3 213113-300  
2×4 213113-400  
2×5 213113-500

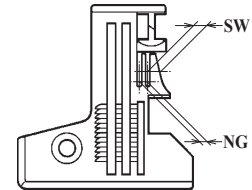

277408-16FO  
277403-16FO 213103-160

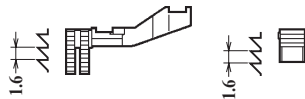

277409-16FO  
277403-16FO 213117-160

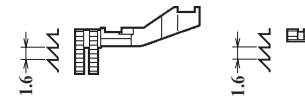

277404-16FO

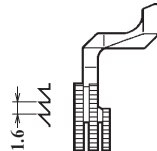

211987C0

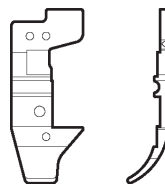

NG×SW  
2×3 2105030 #5  
2×4 2103740 #7  
2×5 2103740 #7



● 針受は2頁を参照してください。  
See page 2 for the needle guards.

EX5114-03/333N

EX5114-04/433

EX5114-04/433N

277022-920

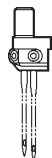

277062B0 #18

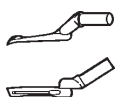

2770630 #19

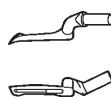

2770010

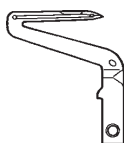

2770600

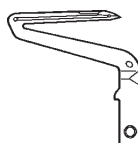

201121A0



2131080

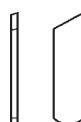

地縫用 (中厚~厚生地)  
PLAIN SEAMING  
(MEDIUM~HEAVY WEIGHT FABRIC)

地縫用 (厚~極厚生地)  
PLAIN SEAMING  
(HEAVY~EXTRA HEAVY WEIGHT FABRIC)

地縫用 (厚~極厚生地)  
PLAIN SEAMING  
(HEAVY~EXTRA HEAVY WEIGHT FABRIC)

● 針受は2頁を参照してください。  
See page 2 for the needle guards.

EX5105-12/223N

SW  
 3 213100-300  
 4 213100-400  
 5 213100-500

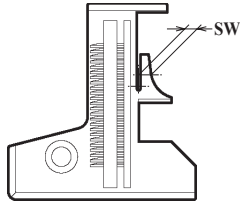

277407-16F0  
 277401-16F0 213103-160

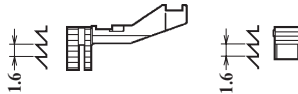

277402-16F0

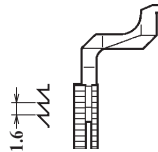

201152E0

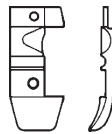

SW  
 3 2771150 #10  
 4 2771030 #11  
 5 2771030 #11



● 針受は2頁を参照してください。  
 See page 2 for the needle guards.

EX5105-12/223N

179630-920



277062A0 #15

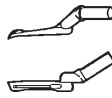

2770600

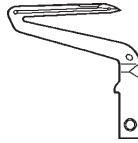

201121A0



SW  
3 213108A0  
4 2131080  
5 2131080

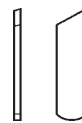

裾引用 (薄~中厚生地)  
BLINDSTITCH HEMMING  
(LIGHT~MEDIUM WEIGHT FABRIC)

● 針受は2頁を参照してください。  
See page 2 for the needle guards.

EX5104-52D/223/MC310.311

EX5104-52D/223/MC501

EX5104-D-52D1/333

SW  
4 277509-400

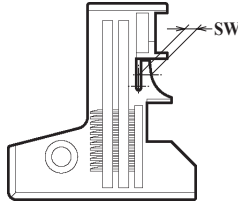

277422-16F0  
277403-16F0 212752A130

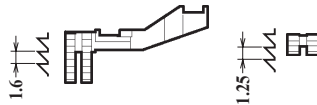

277404-16F0

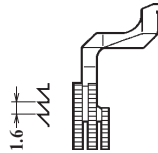

277178-910

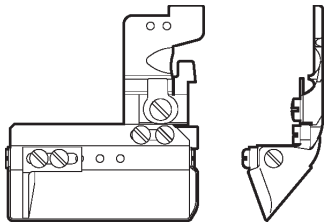

213670-910

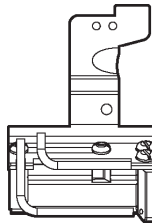

2136720

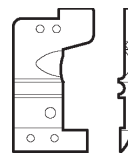

210371B0



● 針受は2頁を参照してください。  
See page 2 for the needle guards.

EX5104-52D/223/MC310.311

EX5104-52D/223/MC501

EX5104-D-52D1/333

179630-920



277022-920



2770620 #14

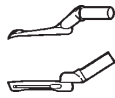

277062B0 #18

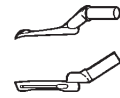

2770600

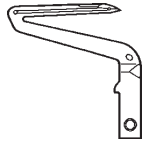

2770010

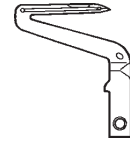

201121A0



2131080

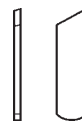

MC用 (薄~中厚生地)  
FOR MC DEVICE  
(LIGHT~MEDIUM WEIGHT FABRIC)

MC用 (薄~中厚生地)  
FOR MC DEVICE  
(LIGHT~MEDIUM WEIGHT FABRIC)

MC用 (薄~中厚生地)  
FOR MC DEVICE  
(LIGHT~MEDIUM WEIGHT FABRIC)

● 針受は2頁を参照してください。  
See page 2 for the needle guards.

EX5114-92M2/223N

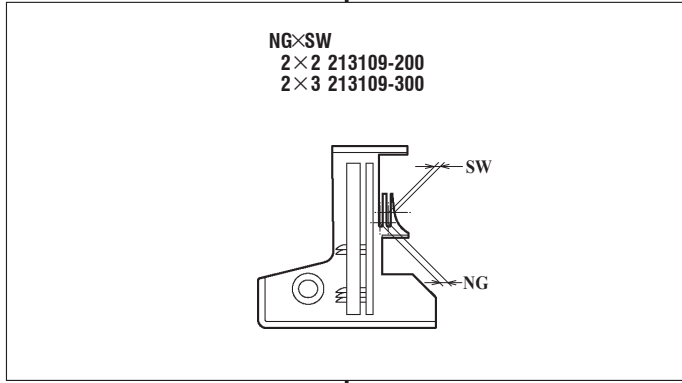

EX5114-92M2/223N/EH001A

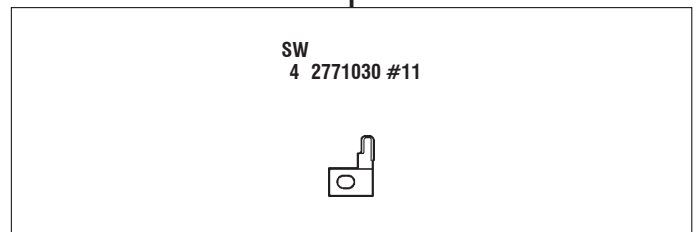
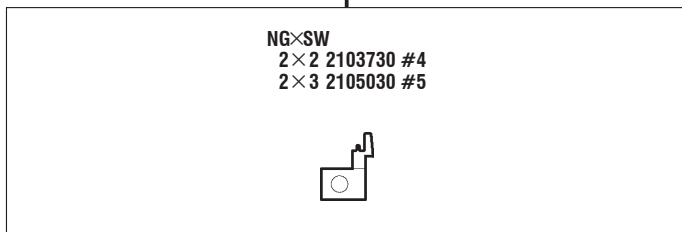
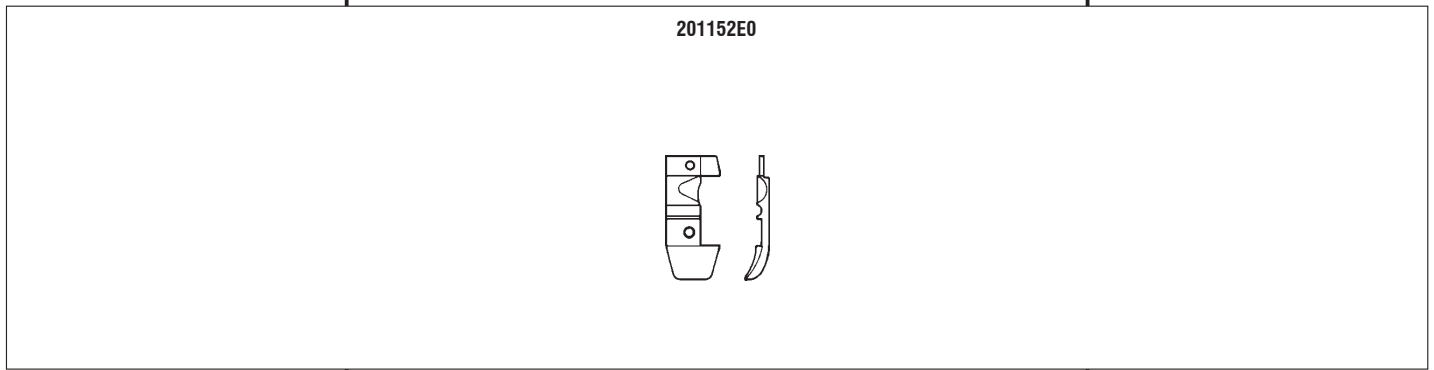
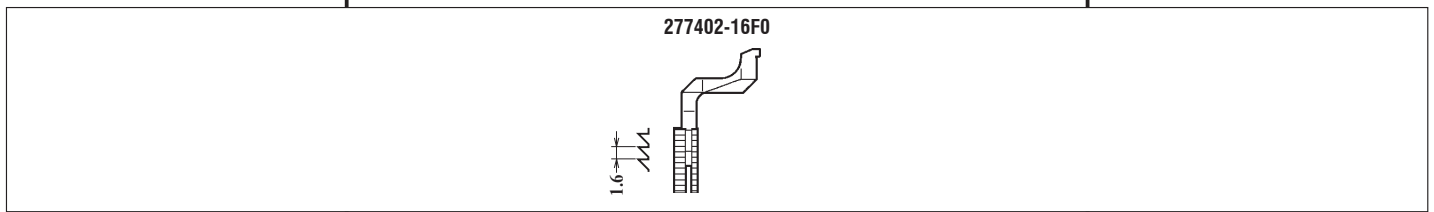
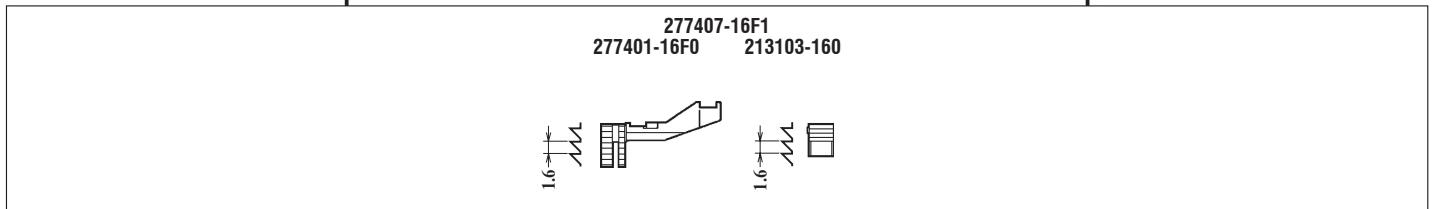
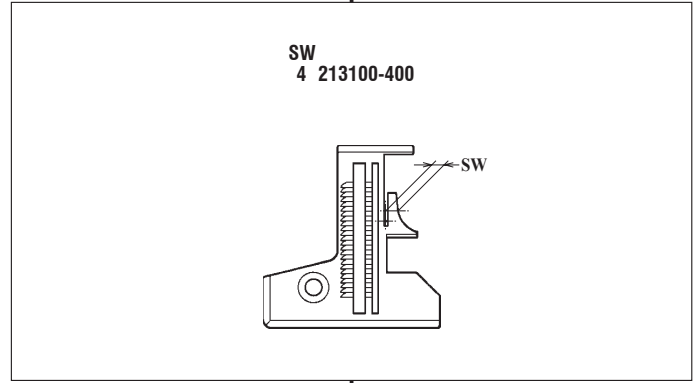

● 針受は2頁を参照してください。  
See page 2 for the needle guards.

EX5114-92M2/223N

EX5114-92M2/223N/EH001A

277022-920

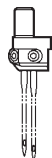

277062C0 #20

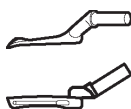

2770600

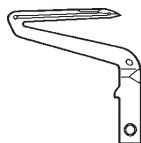

201121A0



2131080

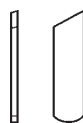

マルチ用 (薄~中厚生地)  
MULTI TYPE  
(LIGHT~MEDIUM WEIGHT FABRIC)

マルチ用 (薄~中厚生地)  
MULTI TYPE  
(LIGHT~MEDIUM WEIGHT FABRIC)

● 針受は2頁を参照してください。  
See page 2 for the needle guards.